

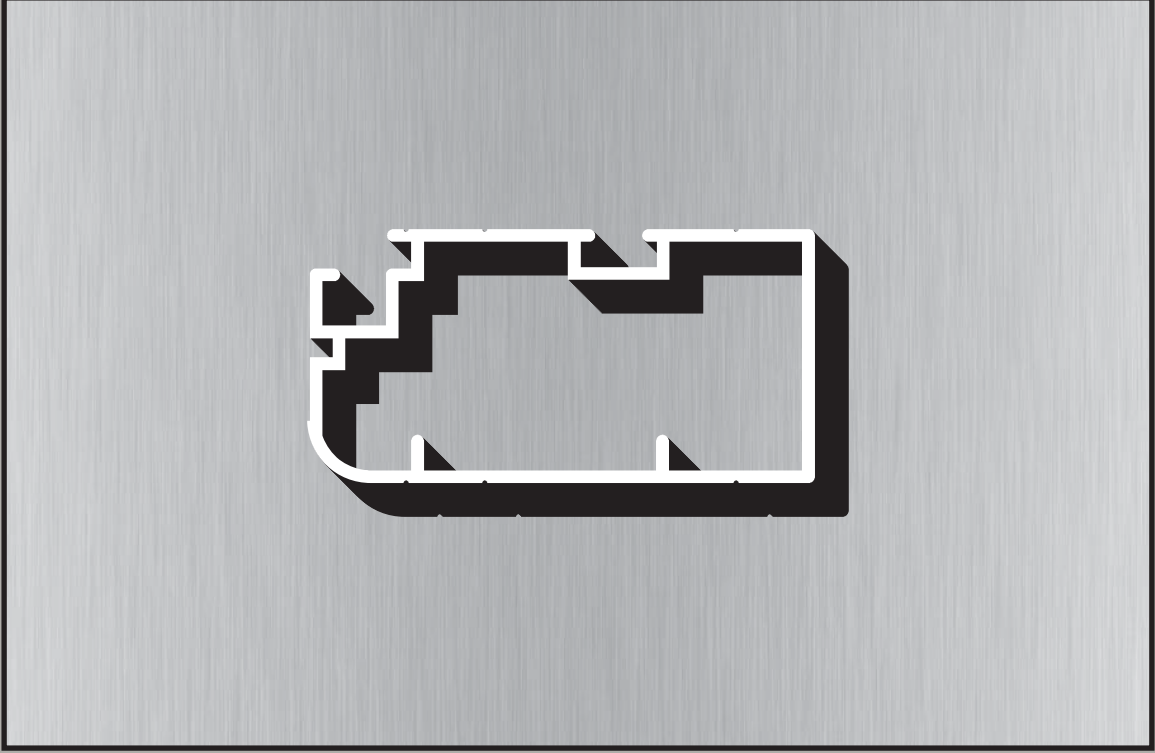

**UZUNER**  
**ALÜMİNYUM**



**SİNEKLİK ve STOR PERDE PROFİLLERİ**

**INSECT SCREEN & ROLLER BLINDS PROFILES**



# UZUNER ALÜMİNYUM

SİNEKLİK ve STOR PERDE PROFİLLERİ / INSECT SCREEN & ROLLER BLINDS PROFILES

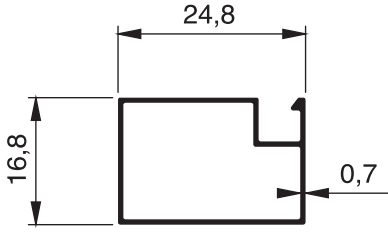

750 - 0.168 Kg/m

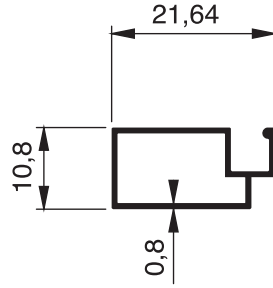

751 - 0.142 Kg/m

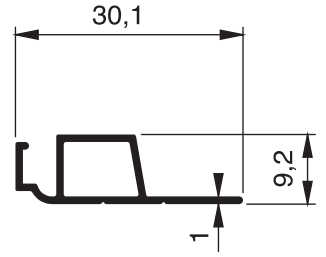

753 - 0.168 Kg/m

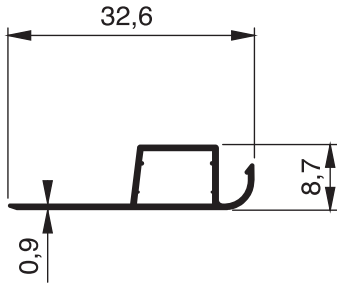

752 - 0.150 Kg/m

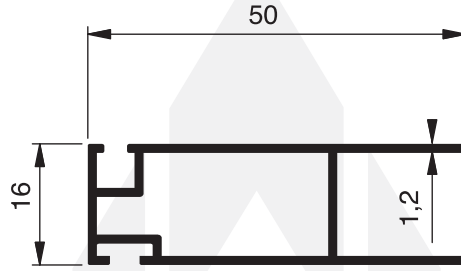

1825 - 0.437 Kg/m

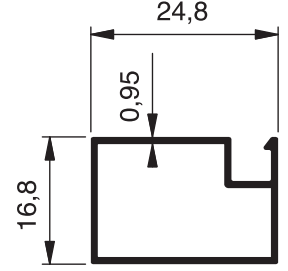

757 - 0.222 Kg/m

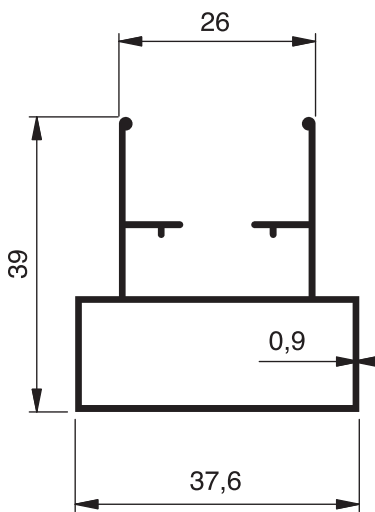

1957 - 0.418 Kg/m

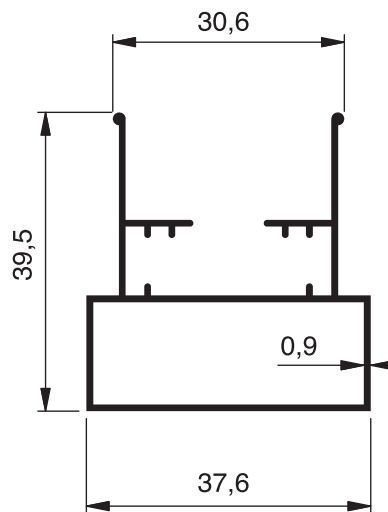

1958 - 0.448 Kg/m

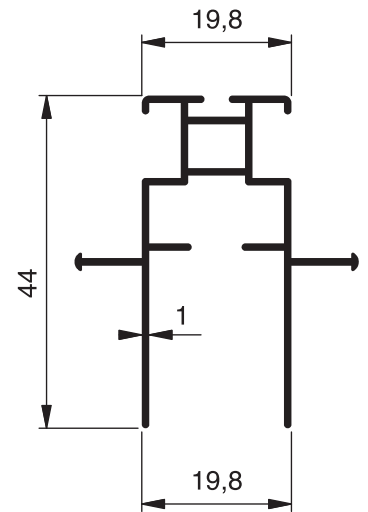

1959 - 0.435 Kg/m

# UZUNER ALÜMİNYUM

SİNEKLİK ve STOR PERDE PROFİLLERİ / INSECT SCREEN & ROLLER BLINDS PROFILES

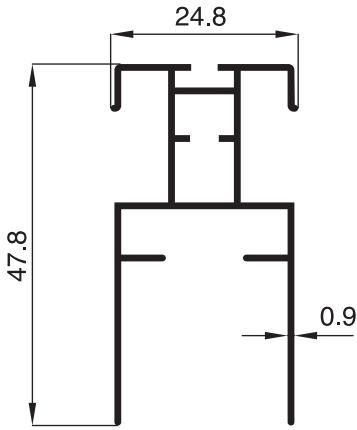

2110 - 0.416 Kg/m

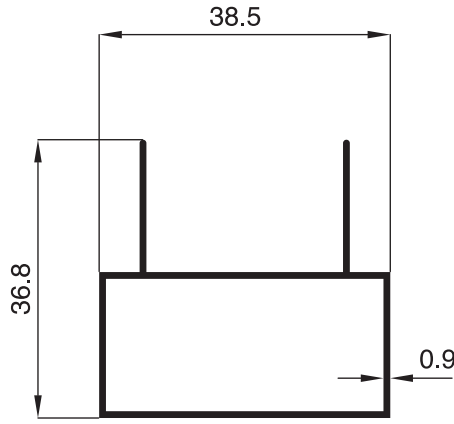

2111 - 0.359 Kg/m

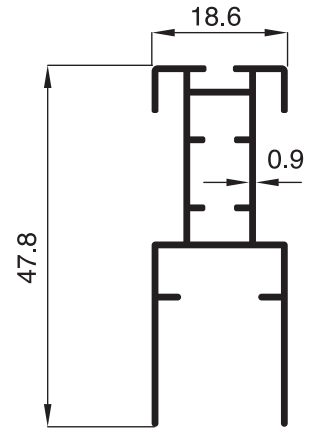

2497 - 0.381 Kg/m

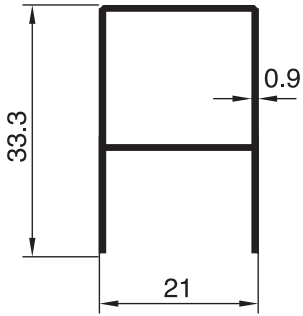

2496 - 0.256 Kg/m

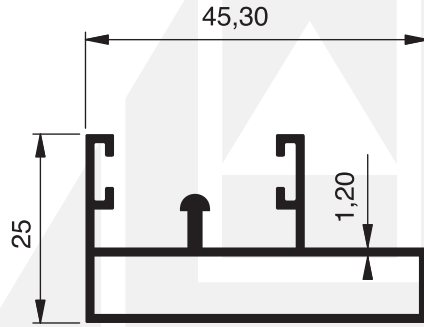

1824 - 0.545 Kg/m

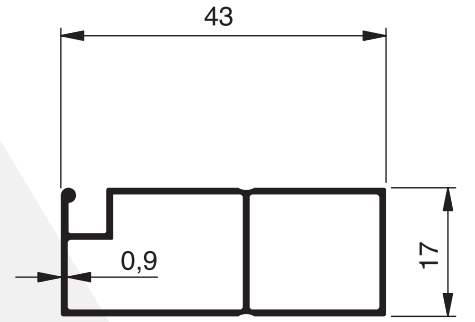

2032 - 0.373 Kg/m

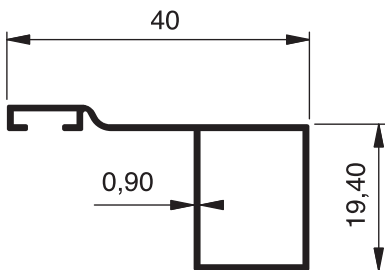

2033 - 0.245 Kg/m

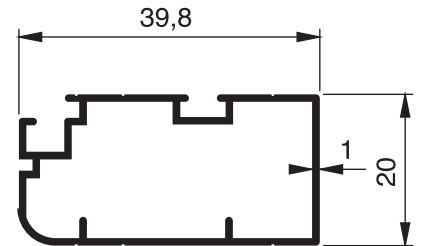

756 - 0.369 Kg/m

# UZUNER ALÜMİNYUM

SİNEKLİK ve STOR PERDE PROFİLLERİ / INSECT SCREEN & ROLLER BLINDS PROFILES

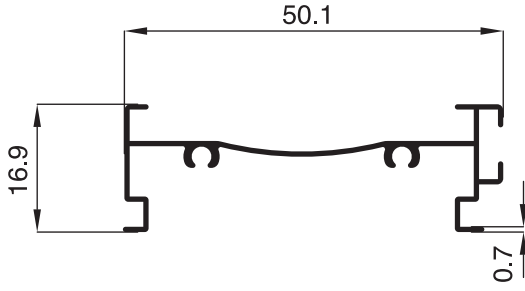

2222 - 0.238 Kg/m

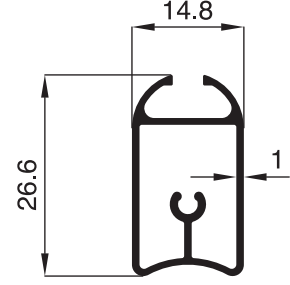

2224 - 0.259 Kg/m

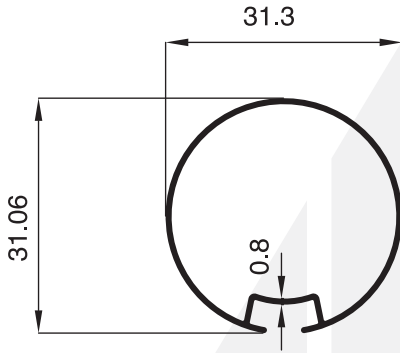

2221 - 0.231 Kg/m

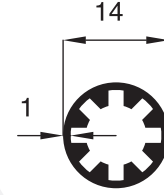

2223 - 0.194 Kg/m

