

2002
0.122 Kg/m

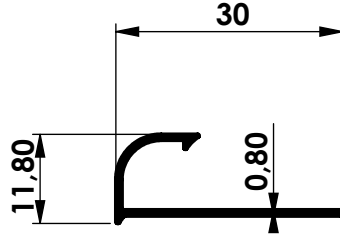

2003
0.108 Kg/m

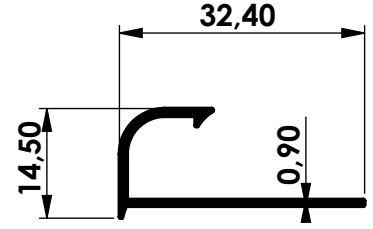

2258
0.141 Kg/m

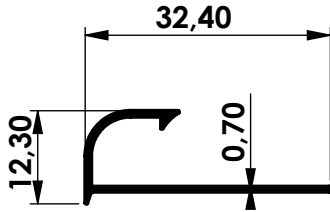

2257
0.109 Kg/m

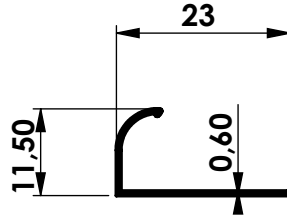

2238
0.061 Kg/m

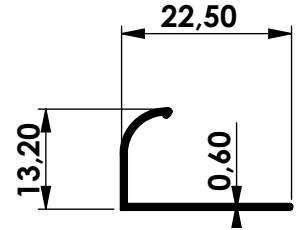

2239
0.064 Kg/m

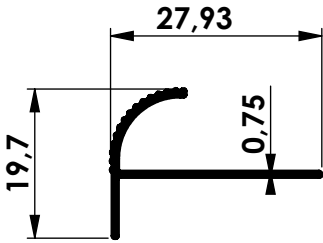

2075
0.112 Kg/m

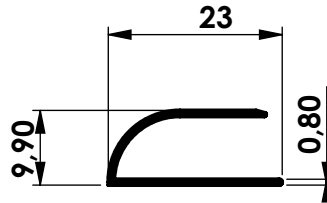

2284
0.104 Kg/m

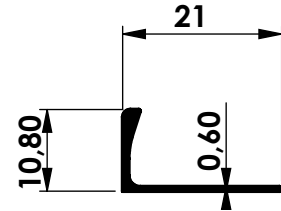

2286
0.068 Kg/m

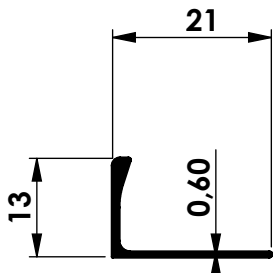

2288
0.073 Kg/m

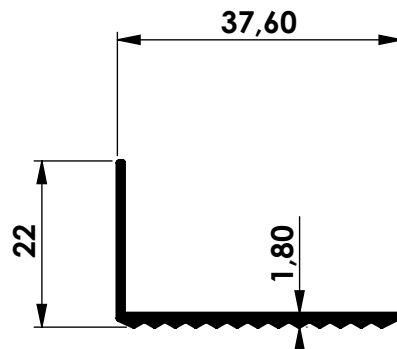

2231
0.190 Kg/m

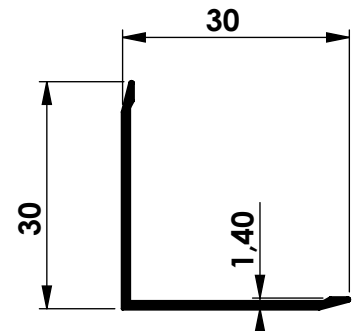

2077
0.141 Kg/m

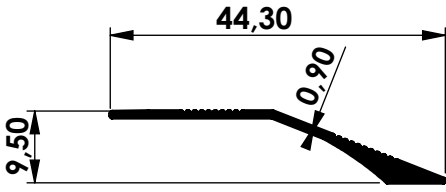

2255
0.150 Kg/m

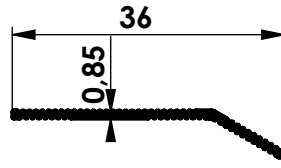

1936
0.089Kg/m

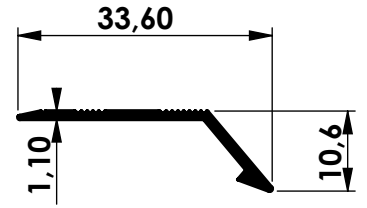

2273
0.112 Kg/m

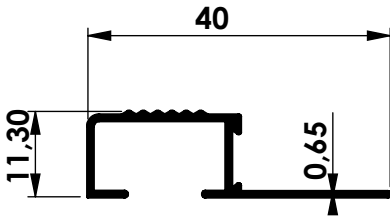

2285
0.143 Kg/m

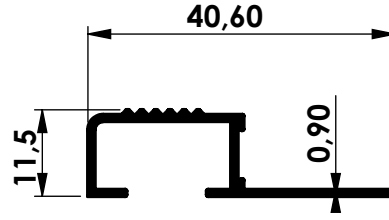

2024
0.181 Kg/m

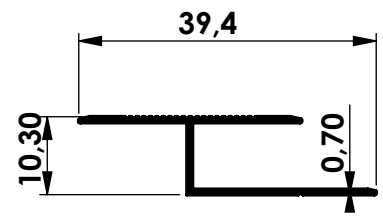

2287
0.120 Kg/m

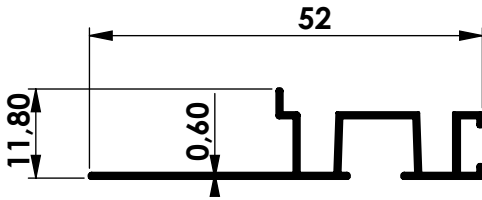

2289
0.160 Kg/m

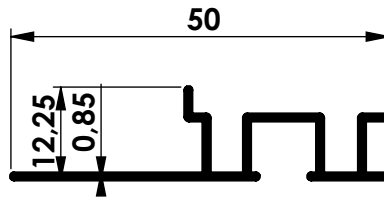

1979
0.212 Kg/m

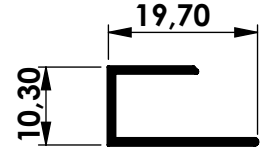

2256
0.087 Kg/m

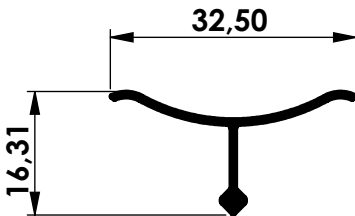

1981
0.111 Kg/m

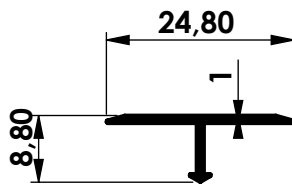

1982
0.087 Kg/m

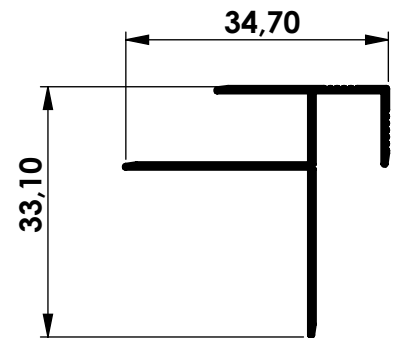

2290
0.190 Kg/m

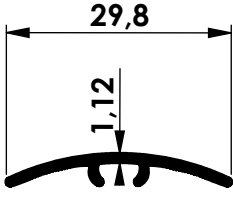

1976
0.108 Kg/m

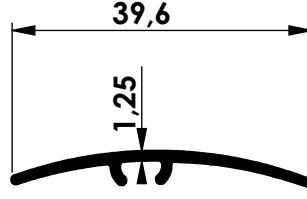

1977
0.137 Kg/m

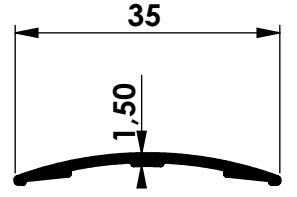

1978
0.113 Kg/m

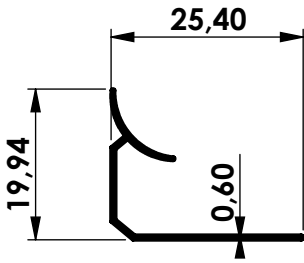

2240
0.083 Kg/m

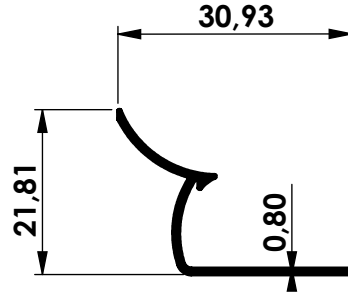

2076
0.116 Kg/m

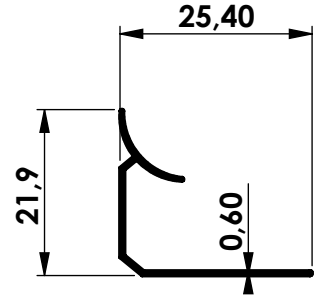

2237
0.086 Kg/m

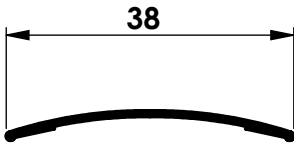

2232
0.088 Kg/m

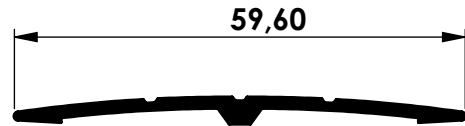

2299
0.247 Kg/m

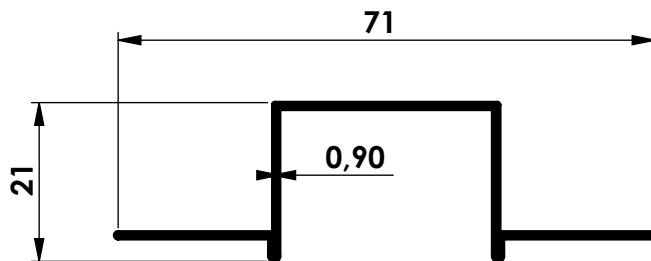

2074
0.280 Kg/m