

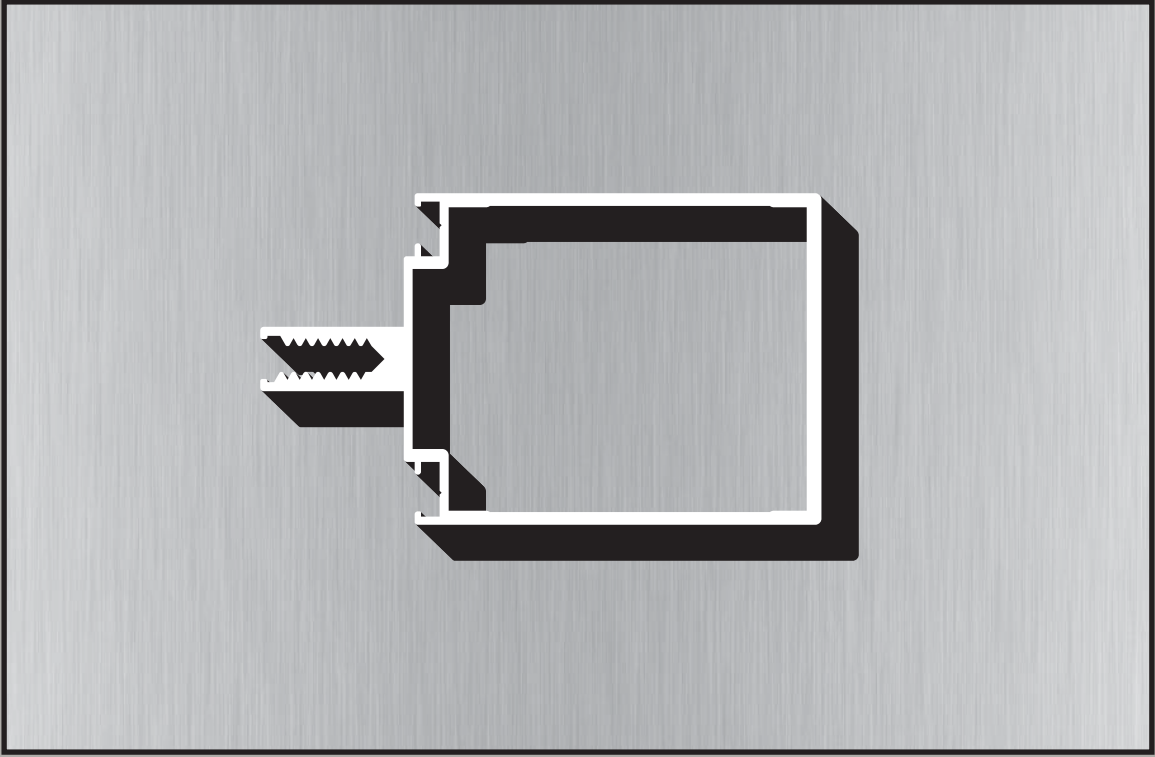

**UZUNER**  
**ALÜMİNYUM**



**CEPHE PROFİLLERİ**  
**FAÇADE PROFILES**



# UZUNER ALÜMİNYUM

CEPHE PROFİLLERİ / FAÇADE PROFILES

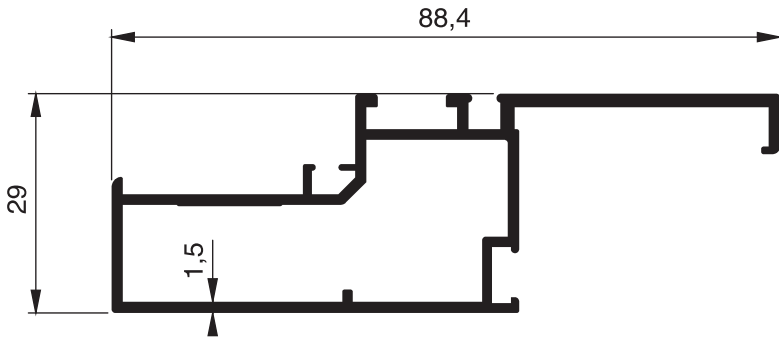

1143 - 0.921 Kg/m

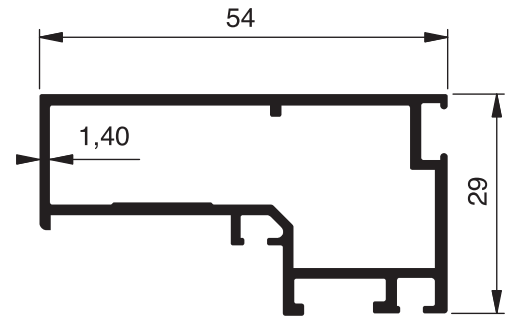

1889 - 0.730 Kg/m

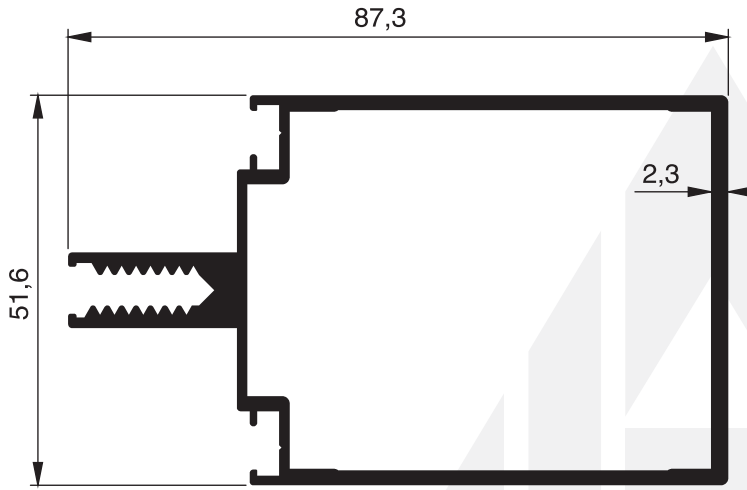

1146 - 1.580 Kg/m

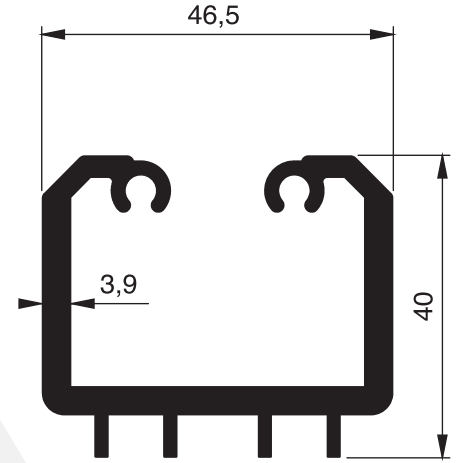

1145 - 1.462 Kg/m

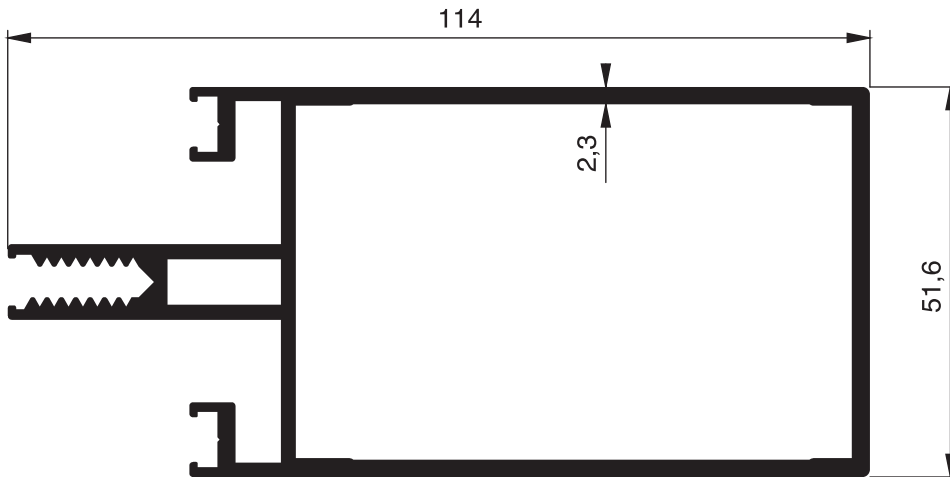

1147 - 2.271 Kg/m

# UZUNER ALÜMİNYUM

CEPHE PROFİLLERİ / FAÇADE PROFILES

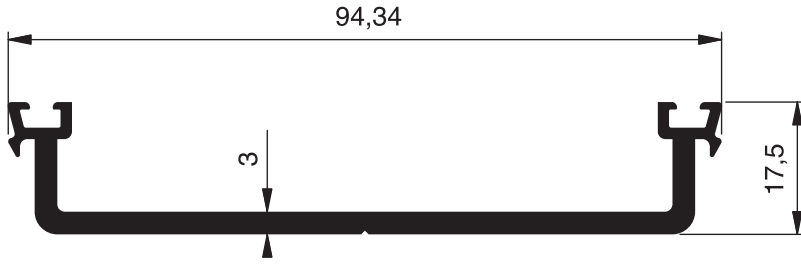

1899 - 1.100 Kg/m

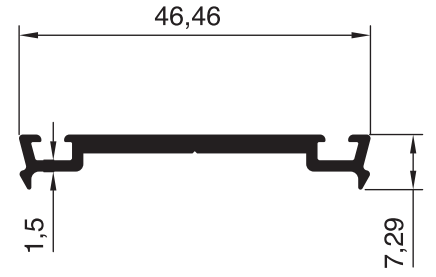

8102 - 0.344 Kg/m

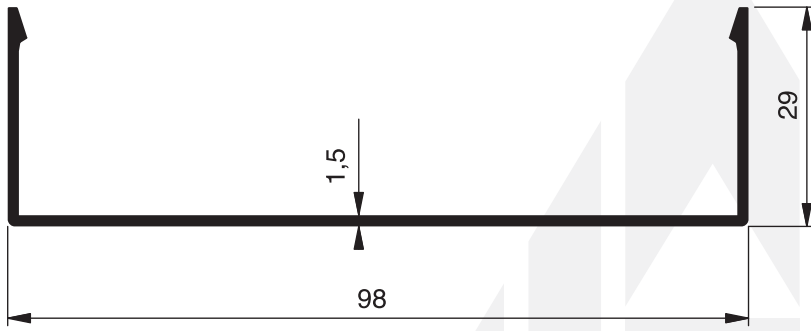

1900 - 0.699 Kg/m

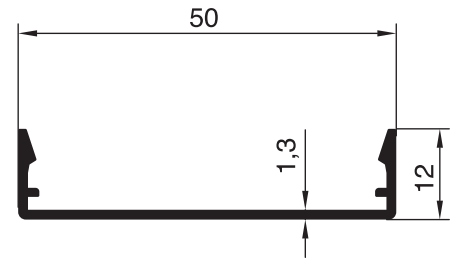

8103 - 0.273 Kg/m

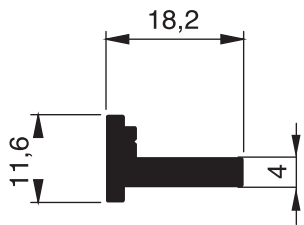

1144 - 0.266 Kg/m

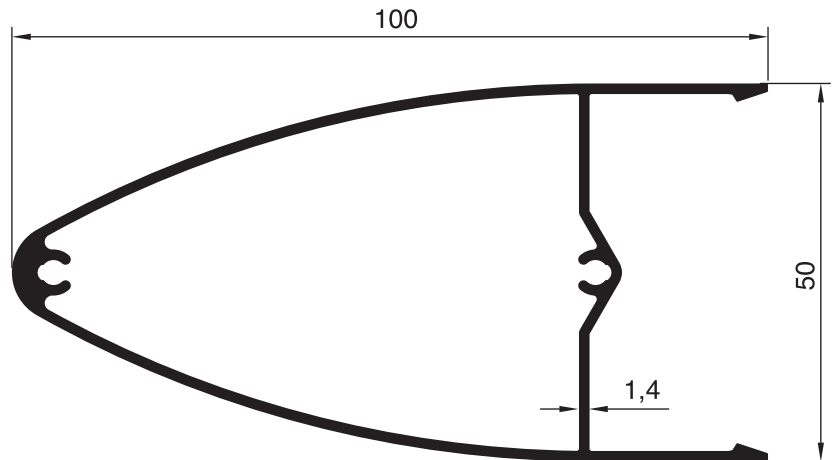

8108 - 1.105 Kg/m